

# Power Defense circuit breakers

## Product guide



# A globally rated platform from Eaton

Power Defense™ molded case circuit breakers (MCCBs) and insulated case circuit breakers (ICCBs) are globally certified to meet your local requirements, empowering you to build and design systems that can be used anywhere in the world. Wherever Eaton does business, Power Defense circuit breakers are there, backed by Eaton's global support and fulfillment network, with the right resources in place to minimize your project lead-time and maximize your uptime. Integrating new products can be a challenge, which is why the Power Defense circuit breakers are available with online instructions, support and a product selector. These unique tools can help you engineer and deliver your projects quickly, ultimately helping to improve your bottom line.

Power Defense circuit breakers—a globally rated platform from Eaton

The Power Defense circuit breakers feature the Power Xpert® Release (PXR) electronic trip units, offering premium protection and communication features allowing you to use fewer components and a simplified design while keeping your system connected, your equipment and employees protected, and your customers informed. The PXR trip unit family has models that will cover all of your needs, including fully programmable models that enable ultimate customization and flexibility, as well as value models that offer all of the benefits of electronic trip units, with simple setup and coordination.

PXR electronic trip units are equipped with the latest micro-processor technology including industry-first advanced algorithms that notify you when your power distribution circuit breaker needs to be maintained or replaced. They also have the embedded ability to accurately measure energy consumption with no additional meters or equipment, delivering critical data about your power distribution system and energy use in your facility.

Whether you're building production capacity or a legacy, the green factory of the future or the newest high rise on the next horizon, Power Defense circuit breakers will serve as guardian and protector as your ideas are realized in concrete and steel.



Molded case circuit breaker



Insulated case circuit breaker

## Power Defense circuit breaker portfolio

### Frame PD-1



**Dimensions**  
3.00 W x 5.50 H x 2.99 D inches  
(76.2 x 139.7 x 76.0 mm)

**Current range**  
15–125 A

**Maximum NEMA voltage**  
347 Y/600 Vac/250 Vdc

**Maximum IEC voltage**  
415 Vac/250 Vdc

**Certifications**  
UL/CSA/CE/CCC

**Interrupting capacity at 480 Vac (kAIC)**  
18, 25, 35, 50, 65, 85, 100

**100% UL rated options**

**Current limiting options**

**Trip unit options**  
T/M fixed fixed

- Through-cover accessories

### Frame PD-2



**Dimensions**  
4.13 W x 6.00 H x 3.38 D inches  
(105.0 x 152.4 x 86.0 mm)

**Current range**  
15–225 A

**Maximum NEMA voltage**  
600 Vac/250 Vdc

**Maximum IEC voltage**  
690 Vac/250 Vdc

**Certifications**  
UL/CSA/CE/CCC

**Interrupting capacity at 480 Vac (kAIC)**  
25, 35, 50, 65, 85, 100

**100% UL rated options**

**Current limiting options**

**Trip unit options**  
T/M fixed fixed  
PXR 10  
PXR 20  
PXR 20D  
PXR 25

**Electronic protection**  
LSI, LSIG

- Through-cover accessories
- Available with 2 PXR communication relays
- 1 Relay with Modbus RTU

### Frame PD-3



**Dimensions**  
5.48 W x 10.13 H x 4.09 D inches  
(139.2 x 257.3 x 104.0 mm)

**Current range**  
45–600 A

**Maximum NEMA voltage**  
600 Vac/250 Vdc

**Maximum IEC voltage**  
690 Vac/250 Vdc

**Certifications**  
UL/CSA/CE/CCC

**Interrupting capacity at 480 Vac (kAIC)**  
25, 35, 50, 65, 85, 100

**100% UL rated options**

**Current limiting options**

**Trip unit options**  
T/M fixed adjustable  
PXR 10  
PXR 20  
PXR 20D  
PXR 25

**Electronic protection**  
LSI, LSIG, ALSI, ALSIG

- Through-cover accessories
- Available with 2 PXR communication relays
- Field-interchangeable trip units

### Frame PD-4



**Dimensions**  
8.25 W x 16.00 H x 4.06 D inches  
(209.6 x 406.4 x 103.1 mm)

**Current range**  
300–800 A

**Maximum NEMA voltage**  
600 Vac/250 Vdc

**Maximum IEC voltage**  
690 Vac/250 Vdc

**Certifications**  
UL/CSA/CE/CCC

**Interrupting capacity at 480 Vac (kAIC)**  
35, 50, 65

**100% UL rated options**

**Trip unit options**  
T/M fixed adjustable  
PXR 10  
PXR 20  
PXR 20D  
PXR 25

**Electronic protection**  
LSI, LSIG, ALSI, ALSIG

- Through-cover accessories
- Available with 2 PXR communication relays
- Field-interchangeable trip units

### Frame PD-5



**Dimensions**  
8.25 W x 16.00 H x 5.50 D inches  
(209.6 x 406.4 x 139.7 mm)

**Current range**  
320–1200 A (UL)  
320–1600 A (IEC)

**Maximum NEMA voltage**  
600 Vac/250 Vdc

**Maximum IEC voltage**  
690 Vac/250 Vdc

**Certifications**  
UL/CSA/CE/CCC

**Interrupting capacity at 480 Vac (kAIC)**  
50, 65, 85, 100, 150

**100% UL rated options**

**Trip unit options**  
PXR 20  
PXR 20D  
PXR 25

**Electronic protection**  
LSI, LSIG, ALSI, ALSIG

- Field-interchangeable accessories
- Available with 3 PXR communication relays
- Field-interchangeable trip units

### Frame PD-6



**Dimensions**  
15.50 W x 16.00 H x 9.00 D inches  
(393.7 x 406.4 x 228.6 mm)

**Current range**  
700–2500 A

**Maximum NEMA voltage**  
600 Vac/250 Vdc

**Maximum IEC voltage**  
690 Vac/250 Vdc

**Certifications**  
UL/CSA/CE/CCC

**Interrupting capacity at 480 Vac (kAIC)**  
65, 85, 100

**100% UL rated options**

**Trip unit options**  
PXR 20  
PXR 20D  
PXR 25

**Electronic protection**  
LSI, LSIG, ALSI, ALSIG

- Field-interchangeable accessories
- Available with 3 PXR communication relays
- Field-interchangeable trip units

### Frame PD-NF



**Dimensions**  
10.00 W x 14.17 H x 7.86 D inches  
(254.0 x 359.9 x 199.6 mm)  
(with cassette)

**Current range**  
200–1200 A (UL 489 option)  
200–1600 A (IEC option)

**Maximum NEMA voltage**  
600 Vac

**Maximum IEC voltage**  
690 Vac

**Certifications**  
UL/CSA or CE/CCC

**Interrupting capacity at 480 Vac (kAIC)**  
42, 50, 65

**100% UL rated**

**Trip unit options**  
PXR 20  
PXR 25

**Electronic protection**  
LSI, LSIG, ALSI, ALSIG

- Field-interchangeable accessories
- Available with 3 PXR communication relays
- Field-interchangeable trip units
- Stored energy mechanism
- Front connect or rear connect; fixed or drawout

### Frame PD-RF



**Dimensions**  
15.76 W x 17.96 H x 9.45 D inches  
(400.3 x 456.2 x 240.0 mm)  
(with cassette)

**Current range**  
800–3000 A (UL 489 option)  
800–4000 A (IEC option)

**Maximum NEMA voltage**  
480 Vac

**Maximum IEC voltage**  
690 Vac

**Certifications**  
UL/CSA or CE/CCC

**Interrupting capacity at 480 Vac (kAIC)**  
65, 85, 100

**100% UL rated**

**Trip unit options**  
PXR 20  
PXR 25

**Electronic protection**  
LSI, LSIG, ALSI, ALSIG

- Field-interchangeable accessories
- Available with 3 PXR communication relays
- Field-interchangeable trip units
- Stored energy mechanism
- Rear connect; fixed or drawout

# Advanced technology and features

## Breaker health

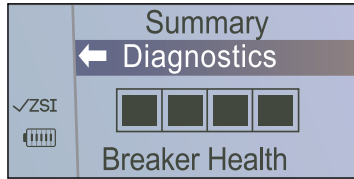

- Industry-first algorithm that provides real-time evaluation of breaker condition by tracking and analyzing diagnostic details including breaker operations, short-circuit fault levels, operational time, internal temperature and overloads
- Monitors and communicates breaker health status, enabling predictive maintenance to avoid costly, unscheduled downtime

## Zone selective interlocking (ZSI)



- Designed to reduce thermal and mechanical stress on distribution equipment and arc flash incident energy released during phase or ground faults by enabling the breaker closest to the fault to override customer-defined delay settings while communicating with upstream and downstream breakers
- PXR trip unit displays ZSI signal indication when system is engaged, communicating and check indication when input signal is detected, allowing network integrity testing and providing operational status

## Arcflash Reduction Maintenance System™



- Industry-leading solution to reduce arc flash energy released during maintenance operations using a separate circuit to provide faster than instantaneous clearing times
- Flexibility to enable system and provide visual indication by communications, remote switch and relay, or directly on the trip unit face
- Adjustable Arcflash Reduction Maintenance System settings via LCD screen or PXPM software

## Enhanced ground fault protection

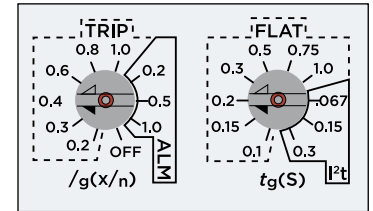

- Expanded ground fault setting options improve coordination capabilities
- Combined functionality to trip and/or alarm, including a pre-alarm option via a programmable relay, provides maximum protection options and system uptime
- An OFF setting also provides flexibility in testing, troubleshooting and inventory management

## Versatile communications options



- Imbedded Modbus RTU
- Additional communications protocols, including Modbus TCP, webpage interface and PROFIBUS, available via Eaton's Communications Adapter Modules (CAM)
- CAM module relays that can be programmed for custom breaker and trip unit visibility

## Cause of trip LEDs

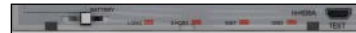

- Cause of trip indication provides insights into a trip event, increasing worker safety and efficiency while troubleshooting
- PXR 20, 20D and 25 include LEDs on the face of the trip unit that will pulse ON/OFF until the unit is reset. An easily replaceable backup battery is included in the trip unit, but only used when no auxiliary power is connected
- All PXR store additional trip event details in their memory that can be easily accessed via the USB port by the PXPM software

## Programmable relays

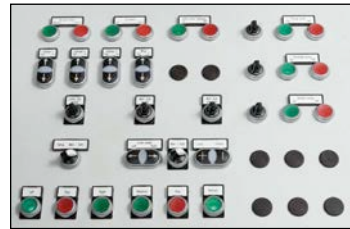

- Multiple programmable relays provide user customizable visibility into breaker and trip unit, such as status, trip events, alarms, and indication of ZSI, Arcflash Reduction Maintenance System or breaker health

## Power Xpert Protection Manager (PXPM) software

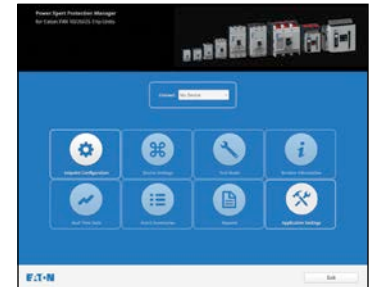

- PXR trip units equipped with micro-USB connection for secondary injection testing through your PC, saving you labor hours and the cost of expensive test kits
- Configure trip unit settings with direct-to-trip unit or offline setup, including duplication of settings between units
- Capture waveforms, monitor real-time power and energy readings, store up to 200 events, create printable test reports and customize display orientation

## Metering capability

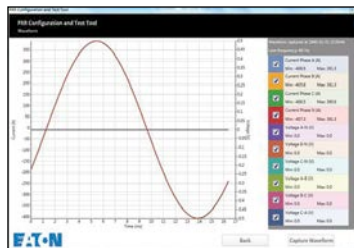

- Current and voltage metering accurate to 0.5% of reading; power and energy metering accurate to 1% of reading
- Voltage metering internal to trip unit with no need for external modules

## LCD display with programmable settings



- Local availability to fully programmable settings, breaker diagnostics, visual customization, event records, injection testing and unit information

# Power Xpert Release (PXR) electronic trip units

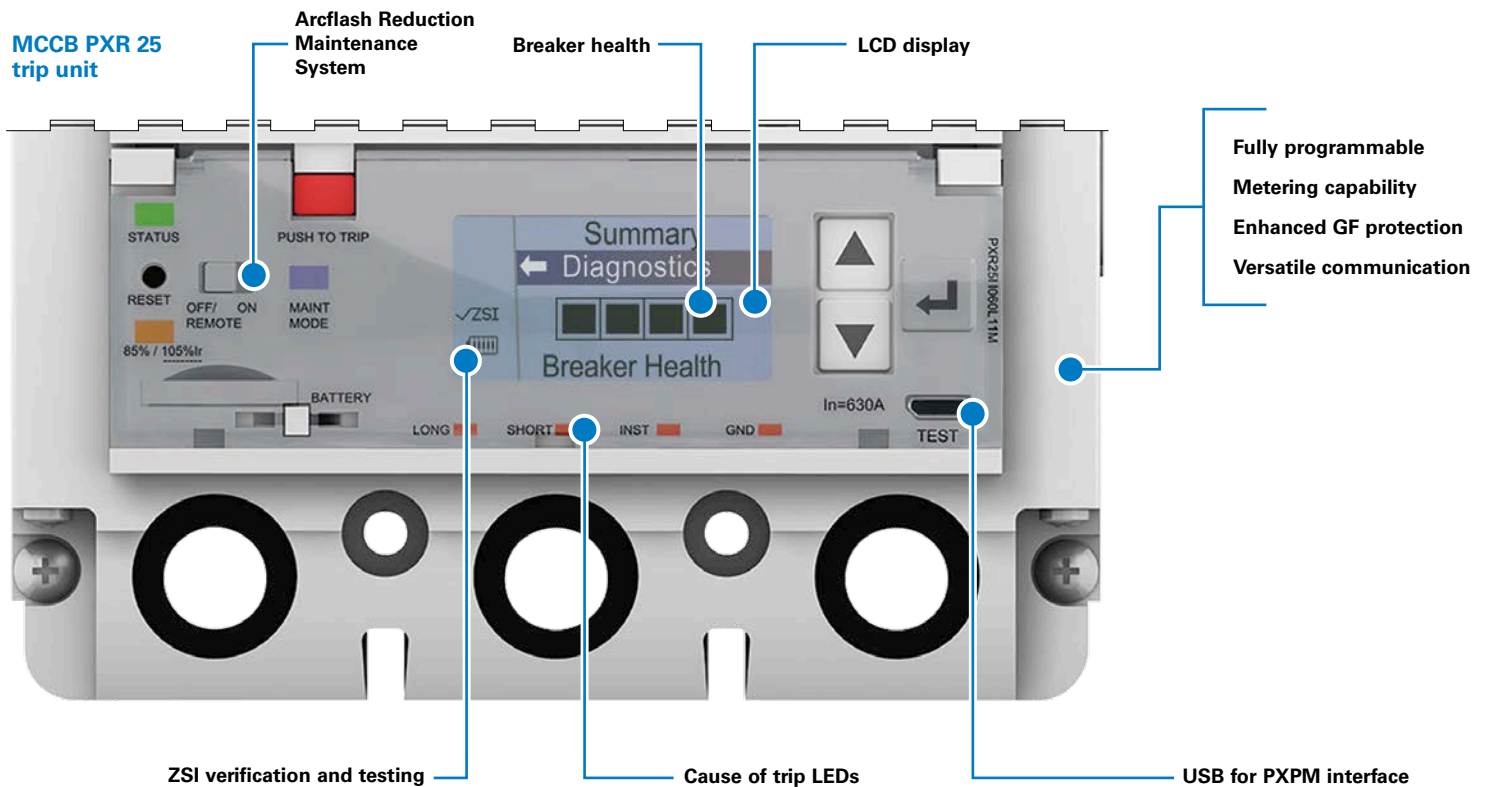

**MCCB PXR 10**



**MCCB PXR 20**



**MCCB PXR 20D**

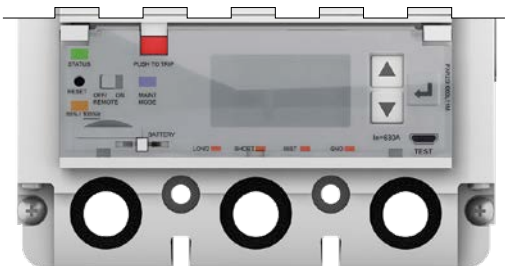

## MCCB PXR features

Features	PXR 10	PXR 20	PXR 20D	PXR 25
Protection types	LSI	LSI/LSIG	LSI/LSIG	LSI/LSIG
Status indication	●	●	●	●
USB secondary injection testing	●	●	●	●
Programmable by USB port (PXPM)	●	●	●	●
Independent instantaneous adjustment	●	●	●	●
Adjustable L, S, I, G pickup and time		●	●	●
Cause of trip indication	▲	●	●	●
Load alarm indication with 2 levels		●	●	●
Programmable load alarm levels			●	●
Ground fault protection and alarm		○	○	○
Arcflash Reduction Maintenance System Available PD3, PD4, PD5, PD6		○	○	○
Zone selective interlocking (ZSI) with indication		○	○	○
Programmable relays		○	●	●
Modbus RTU communication		○	●	●
CAM module communication		○	○	○
Rotatable LCD display			●	●
Breaker health and diagnostic monitoring		▲	●	●
Current metering accuracy		2.0%	0.5%	0.5%
Voltage metering accuracy				0.5%
Power and energy metering accuracy				1.0%

● Standard

○ Optional

▲ Available through USB port (PXPM)

## ICCB PXR 20

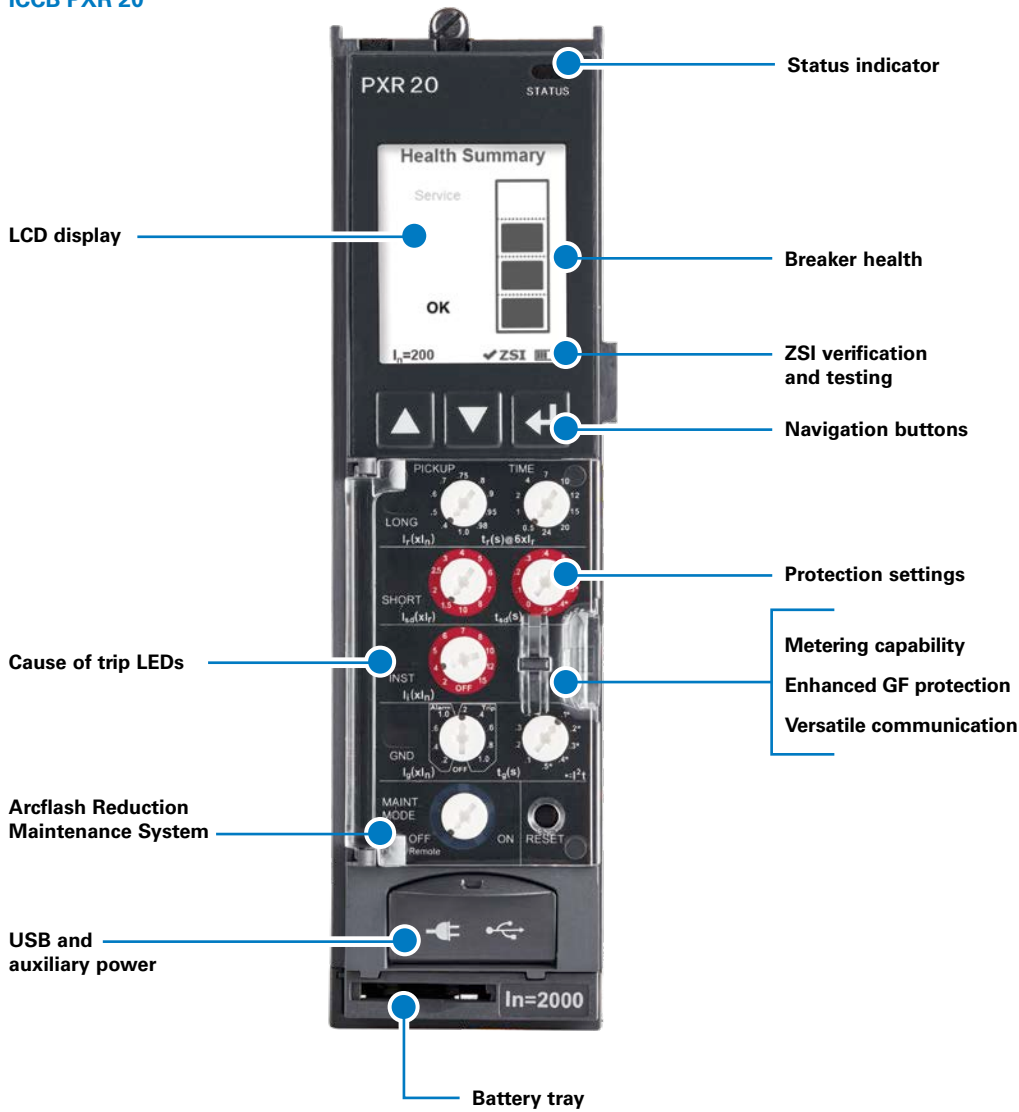

## ICCB PXR features

Features	20 ICCB	25 ICCB
Protection types	LSI/LSIG	LSI/LSIG
Status indication	●	●
USB secondary injection testing	●	●
Programmable by USB port (PXPM)	●	●
Independent instantaneous adjustment	●	●
Adjustable L, S, I, G pickup and time	●	●
Cause of trip indication	●	●
Load alarm indication with 2 levels	●	●
Programmable load alarm levels	●	●
Ground fault protection and alarm	○	○
Arcflash Reduction Maintenance System Available PD-NF, PD-RF	○	○
Zone selective interlocking (ZSI) with indication	●	●
Programmable relays	●	●
Modbus RTU communication	○	●
CAM module communication	●	○
Rotatable LCD display	●	●
Breaker health and diagnostic monitoring	●	●
Current metering accuracy	1.0%	1.0%
Voltage metering accuracy		1.0%
Power and energy metering accuracy		2.0%

● Standard

○ Optional

▲ Available through USB port (PXPM)

# What will you build? And how will you defend it?



## Eaton's Power Defense breaker product selectors

- Web interface to assist in breaker detail selection
- Adjusts for mobile access
- Downloadable 2D and 3D models in over 80 different formats
- Downloadable technical data sheets



MCCB selector



ICCB selector

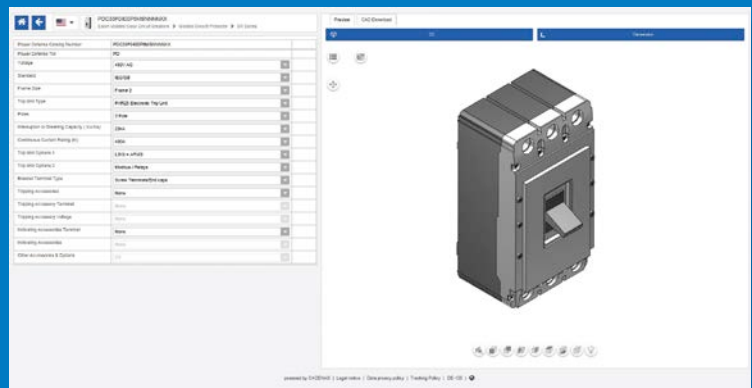
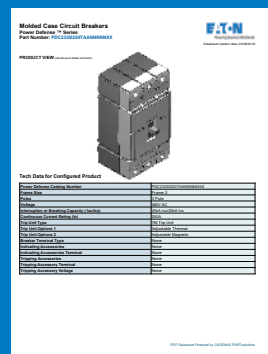
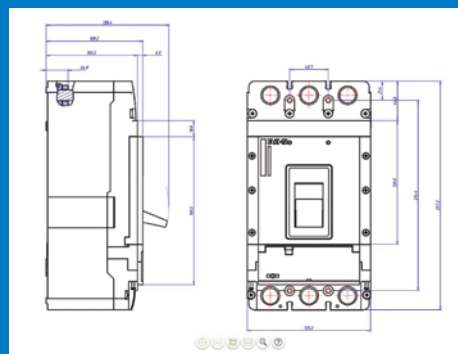



**Our defense is  
your best offense.**

When Power Defense circuit breakers safeguard your structure's power system, you are getting the latest protection technology, engineered for the future: Industry 4.0 features such as built-in communications, advanced energy metering and algorithms that notify you when your circuit breaker needs maintenance, as well as zone selective interlocking technology that clears faults quickly and locally, preventing propagation into your system. Arc flash reduction options help protect your people with the fastest tripping speed technology, not to mention Eaton's best-in-class support and service. You are freeing yourself and your customers from concerns and gaining the sort of assurance that allows your people to move and plan with confidence. That's why our defense is your best offense.

## Power Defense



A globally rated platform from Eaton.

**For more information, call 1-877-ETN-CARE (1-877-386-2273),  
or visit [Eaton.com/powerdefense](https://www.eaton.com/powerdefense)**

**Eaton**  
1000 Eaton Boulevard  
Cleveland, OH 44122  
United States  
[Eaton.com](https://www.eaton.com)

© 2021 Eaton  
All Rights Reserved  
Printed in USA  
Publication No. BR012016EN / Z25689  
November 2021

Eaton is a registered trademark.

All other trademarks are property  
of their respective owners.

Follow us on social media to get the  
latest product and support information.

